



# Konnect

Quality made in Germany by Kindermann

## MultiMedia connection systems

Modular and versatile

The modular MultiMedia connection system can easily integrate computer, video, audio, control or network connections in socket systems, desktop casings, floor boxes and 19" rack patch panels.

It puts an end to ugly cables lying or hanging around! Choose from the biggest product range on the market.

Ready for the future

The modular system can be expanded any time by adding more adapter plates.

### Konnect family

The high-quality adapter plates are available for various applications and in different designs and materials.

Konnect design click

Konnect 50 alu/50 steel

Konnect 54 alu

Konnect flex 45 click

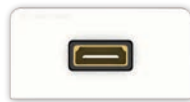

Applications	Suitable for the following applications			
Socket systems 	✓	✓	✓	
CablePort basic/standard 		✓		
CablePort desk/desk <sup>2</sup> CablePort standard <sup>2</sup> CablePort flex module holder CablePort manager 				✓
Floor box kits 		✓		
19" rack patch panels 		✓		

# Konnect

## Rear side version

Available as: clamp connection, soldering connection or plug-in version

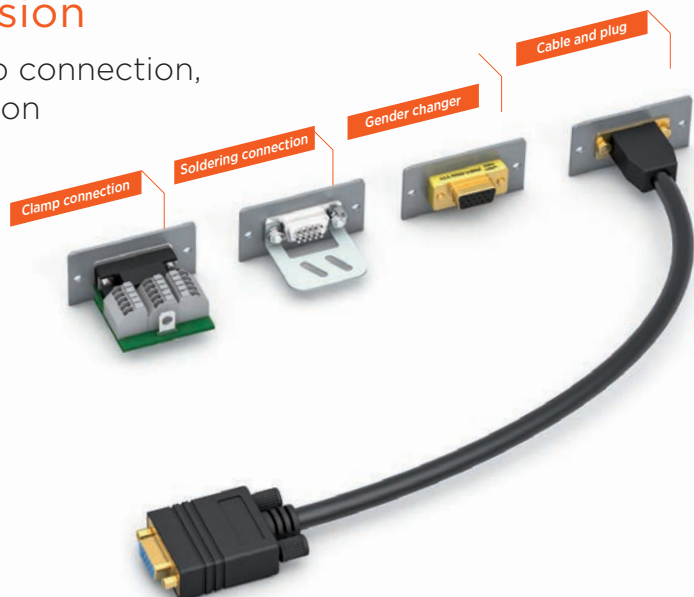

### Cable and plug

Most adapter plates with cable and plug are available in 3 different sizes:

- socket (f) / socket (f) with approx. 20 cm cable and plug
- socket (f) / plug (m) with approx. 1 m cable and plug
- socket (f) / plug (m) with approx. 3 m cable and plug

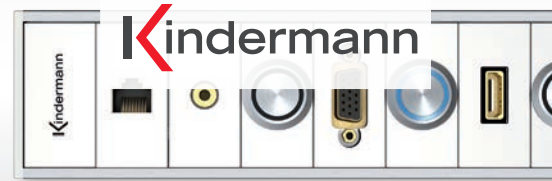

## Compatibility table

Manufacturer	Programme	Compatibility		
<b>Berker</b>	S1, B1, B3, B7 Glas, Modul 2, Arsys, K.1/K.5, 21	✓		✓
	S1, B1, B3, B7 Glas		✓	✓
<b>Busch-Jaeger</b>	Reflex SI (linear), Duro 2000 Si (linear), Solo, Future (Linear), Carat, Alpha exclusive, Alpha nea, Impuls, Busch-axent Pur stainless steel	✓		✓
	Reflex SI (linear), Duro 2000 Si (linear), balance SI		✓	✓
<b>Elso</b>	Riva, Scala, Fashion (each only with ELSO-combination frame 55 x 55), Joy		✓	
<b>Gira</b>	Event, E2, E22 white, Esprit, Standard 55, stainless steel, aluminium, S-Color, surface, S-Classic, E22, Classix (with Gira frame)	✓		✓
	Event, E2, E22 white, Esprit, Standard 55		✓	✓
<b>Jung</b>	A 500, AS 500, AS universal, A plus, A creation, LS design, AS universal, CD 500, ST 550, CD universal, CD plus	✓		✓
	A 500, AS 500, AS universal, A plus, A creation, LS design, LS 990*, LS plus*, LS 990*, stainless steel*, Aluminium*, anthracite*, polished chrome*, gold		✓	✓
<b>Hager/Tehalit</b>	Kallysto pur, Kallysto stil, Kallysto art	✓		✓
<b>Kopp</b>	Paris, Objekt HK05	✓		✓
	Milano		✓	✓
<b>Legrand-BTicino</b>	Creo, Galea Life	✓		✓
<b>Merten</b>	Atelier, M-Arc, M-Plan, M-Smart, M-Plan II, M1, M-Star, Artec, Antik, Octocolor, System Basic, System surface, System M, Transcent	✓		✓
	Atelier, M-Arc, M-Plan, M-Smart, 1-M, M-Star		✓	✓
<b>Peha</b>	Standard, Dialog, Nova, Aura	✓		✓
<b>Presto-Vedder</b>	Regina, Alessa, Alessa Plus, Fiorena	✓		✓
<b>Siemens</b>	Delta i System, Delta vita, Delta miro, Delta profil, Delta style, Delta ambiente	✓		✓
	Delta i System, Delta vita, Delta miro, Delta profil, Delta style, Delta ambiente (each in connection with Siemens frame 55 x 55 mm)		✓	✓

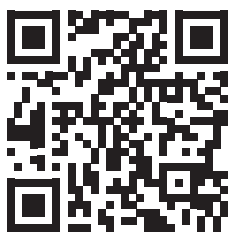

Compatible with socket systems  
from well-known European manufacturers

For details please see <http://www.kindermann.de/konnect>



**NEW**

**K**onnect *design* **click** Media technology perfectly integrated



- Modern and attractive design
- No visible screws on the front plate, for a visually perfect integration
- Front plate of white plastic (RAL 9010)
- Extensive assortment of data and AV interfaces
- High flexibility - to be configured according to customer's wishes
- Simplified mounting
- Compatible with the latest socket systems of all manufacturers

**Quality  
made  
in  
Germany**  
by Kindermann

Front plates in three sizes are included in the package

- Suitable for socket systems with inner dimensions of 50 x 50 mm, 54 x 54 mm and 55 x 55 mm.



Metal holder

- With mounted communication interfaces
- Isolated for floating mounting

Installation with the „click“

- Easy and quick mounting
- No tools needed

Bring together...

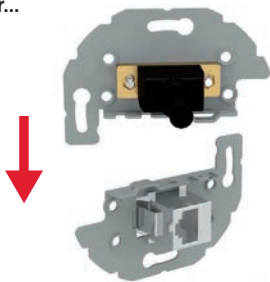

rotate...

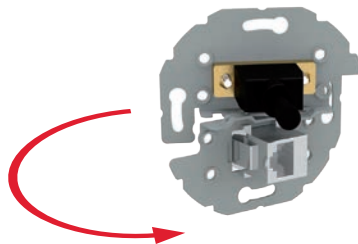

click!



**K**onnect *design* **click** Installation scheme of a socket cover

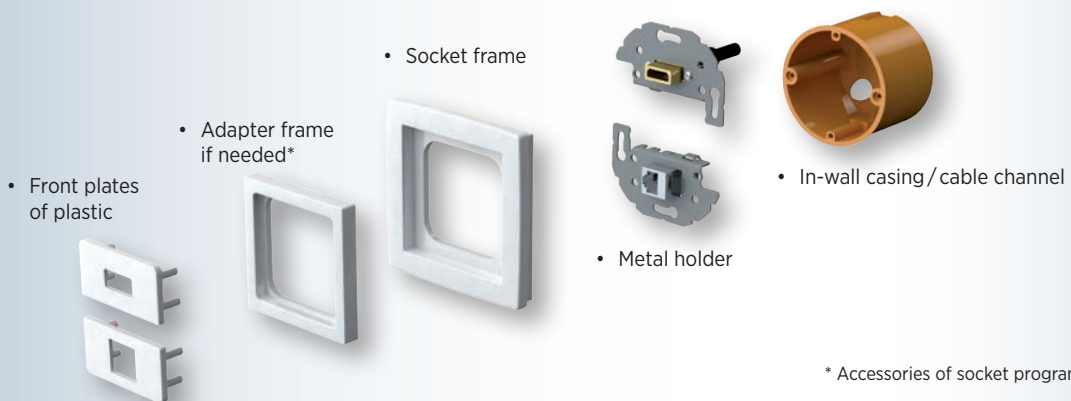

\* Accessories of socket programmes

## Konnect design click - HDBaseT

Connection plate with transmitter resp. receiver for transmission of HDMI signals up to 70 m via cat-5e/6 cable

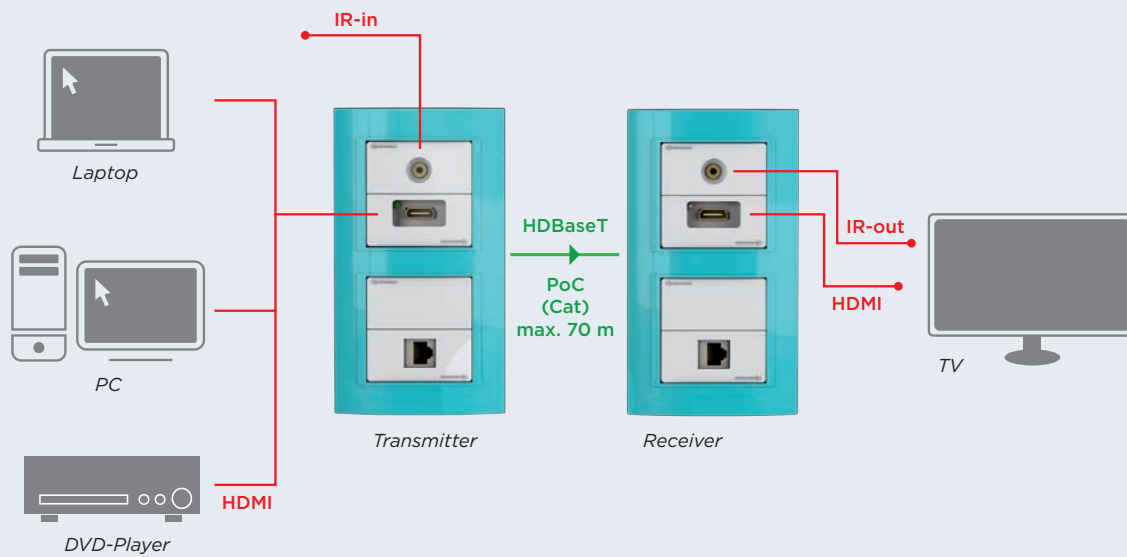

- Signal transmission via HDBaseT
- Transmission range max. 70 m
- Each 1x: HDMI, RJ45 (HDBaseT)
- Cat-6 for network (gender changer) separate
- 3.5 mm jack for infra-red transmission as input resp. output (only 7456000545)
- Supports HDCP, EDID, HDMI 1.4, 3D and 4K x 2K
- Status LED for connection (link)
- PoC (Power over Cable), i. e. only one voltage supply for transmitter and receiver is needed, e. g. power supply with a plug (7488000027) or in-wall solution (5555000119)
- Requires 2-fold socket system and a deep 2-gang in-wall casing (7441000008)
- Also available as floor box version (7445000012)



## Konnect design click - HDBaseT

Illustration	Model	Ref. No.
	Transmitter, double plate with cat-6 gender changer	7456 000 543
	Receiver, double plate with Cat-6 gender changer	7456 000 544
	Transmitter & receiver set, incl. infra-red transmission with Cat-6 gender changer	7456 000 545

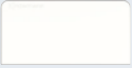
## Konnect design click - Faceplates

Illustration	Model	Ref. No.
	Faceplate, half size plate	7456 000 400
	Faceplate, full size plate	7456 000 500

## Konnect design click - Computer

Illustration	Model	Connection, rear side	Ref. No.
	HDMI Highspeed with Ethernet, half size plate Required installation depth for Cable+plug: 52 mm Clamp: 42 mm	Cable+plug Clamp	7456 000 542 7456 000 740
	HDMI Highspeed with Ethernet, 90°, half size plate Required installation depth: 25 mm	Cable+plug	7456 000 582
	DisplayPort, half size plate Required installation depth: 55 mm	Cable+plug	7456 000 588
	DisplayPort, 90°, half size plate Required installation depth: 20 mm	Gender changer	7456 000 583
	DVI-I (24+5-pin), full size plate Required installation depth: 65 mm	Cable+plug	7456 000 502
	DVI-I to HDMI, full size plate Required installation depth: 52 mm	Cable+plug	7456 000 580
	VGA (HD15), half size plate Required installation depth for Cable+plug: 47 mm Clamp: 47 mm	Cable+plug Gender changer Clamp	7456 000 501 7456 000 601 7456 000 701
	HDMI Highspeed with Ethernet, VGA (HD15), Audio 3.5 mm jack, full size plate Required installation depth: 52 mm	Cable+plug	7456 000 586









## Konnect design click - For installation cable 19/13-pin

Illustration	Model	Connection, rear side	Ref. No.
	<b>HDMI to 19-pin</b> , half size plate Required installation depth: 52 mm	Cable+plug, plug	7456 000 561
	<b>DVI-D to 19-pin</b> , full size plate Required installation depth: 60 mm	Cable+plug, plug	7456 000 560
	<b>VGA, fully configured to 13-pin</b> , half size plate Required installation depth: 67 mm	Cable+plug, plug	7456 000 552
	<b>VGA with DCC support, audio to 13-pin</b> , 2 half size plates Required installation depth: 54 mm	Cable+plug, plug	7456 000 556
	<b>VGA, video, audio to 13-pin</b> , full size plate Required installation depth: 54 mm	Cable+plug, plug	7456 000 551







## Konnect design click - Video

Illustration	Model	Connection, rear side	Ref. No.
	<b>Video (cinch)</b> , half size plate Required installation depth: 47 mm	Cable+plug	7456 000 503
	<b>S-video</b> , half size plate Required installation depth: 47 mm	Cable+plug	7456 000 504
	<b>Video, audio L/R</b> , half size plate Required installation depth: 47 mm	Cable+plug	7456 000 530
	<b>BNC 1-fold</b> , half size plate Required installation depth: 47 mm	Gender changer	7456 000 537
	<b>BNC 2-fold</b> , half size plate Required installation depth: 47 mm	Gender changer	7456 000 538

## Konnect design click - Audio

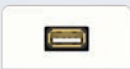



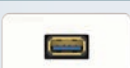





Illustration	Model	Connection, rear side	Ref. No.
	<b>Audio L/R (cinch)</b> , half size plate Required installation depth for Soldering: 30 mm Cable+plug: 47 mm	Soldering Cable+plug	7456 000 410 7456 000 510
	<b>Audio (jack 3.5 mm)</b> , half size plate Required installation depth for Soldering: 30 mm Cable+plug: 47 mm	Soldering Cable+plug	7456 000 411 7456 000 511
	<b>Audio (jack 6.3 mm)</b> , half size plate mit Schaltkontakt Required installation depth: 37 mm	Soldering	7456 000 417
	<b>Audio XLR socket (3-pin)</b> , full size plate Required installation depth: 40 mm	Soldering	7456 000 412
	<b>Audio XLR plug (3-pin)</b> , full size plate Required installation depth: 40 mm	Soldering	7456 000 416
	<b>Speaker</b> , half size plate Suitable for loudspeaker cables or pin plugs up to 4 mm <sup>2</sup> Required installation depth: 37 mm	Screw+clamp	7456 000 414
	<b>Speakon (4-polig)</b> , full size plate Rated current 40 A Required installation depth: 40 mm	Soldering	7456 000 413
	<b>Volume control audio L/R</b> , full size plate Required installation depth: 35 mm	Cable+plug	7456 000 518

## Konnect design click - Network / Data

Illustration	Model	Connection, rear side	Ref. No.
	<b>Cat-6a (RJ45)</b> , half size plate Required installation depth for Cable+plug: 52 mm Cut+clamp: 52 mm	Cable+plug Gender changer Gender changer (BTR) Cut+clamp	7456 000 527 7456 000 523 7456 000 526 7456 000 423
	<b>Cat-7 (GG45/RJ45)</b> , half size plate socket from „Nexans“, certified up to 1000 MHz, downward compatible with RJ45, suitable for AWG 24 - 22 Required installation depth: 65 mm	Cut+clamp	7456 000 424
	<b>Serial RS232</b> , half size plate (9-pin SubD) Required installation depth: 42 mm	Cable+plug	7456 000 520
	<b>USB 2.0 (A-socket/A-socket)</b> , half size plate Required installation depth: 42 mm	Cable+plug	7456 000 522
	<b>USB 2.0 (B-socket/A-socket)</b> , half size plate Required installation depth: 42 mm	Cable+plug	7456 000 525
	<b>USB extender 1.1</b> , half size plate with integrated USB extender (5772000001) for USB 1.1, max. cat-5 cable length between sender and receiver: 45 m Required installation depth: 42 mm + transmitter	Cable+plug	7456 000 524
	<b>USB 2.0 active Hub</b> , half size plate B-socket/A-socket with integrated repeater for max. 5 m cable length Required installation depth: 42 mm + hub	Cable+plug	7456 000 528
	<b>USB 3.0 (A-socket/A-socket)</b> , half size plate Required installation depth: 42 mm	Cable+plug	7456 000 529



## Mounting material for socket systems

Illustration	Model	Connection	Ref. No.
	Mounting frame for adapter plates (7441 / 7444 / 7451 000 xxx)	with plastic adapter frame for adapter plates 54 x 54 mm (7441 000 xxx) and socket covers with inner dimensions 55 x 55 mm	7442 000 001
	Socket cover 1-gang incl. mounting frame	Jung AS500, white, suitable for adapter plates 54 x 54 mm (7441 000 xxx)	7441 000 021
	Socket cover 2-gang incl. mounting frame	Jung AS500, white, suitable for adapter plates 54 x 54 mm (7441 000 xxx)	7441 000 022
	Socket cover 1-gang incl. mounting frame	Busch Jaeger, Reflex SI, white, suitable for adapter plates 54 x 54 mm (7441 000 xxx)	7441 000 001
	Socket cover 2-gang incl. mounting frame	Busch Jaeger, Reflex SI, white, suitable for adapter plates 54 x 54 mm (7441 000 xxx)	7441 000 002
	Safety mains socket for Schuko plug	Busch Jaeger, Reflex SI, white	7441 000 010
	On-wall casing (1-gang)	Busch Jaeger, Reflex SI, white, incl. pre-cut cable outlet, suitable for 7441 000 001	7441 000 003
	On-wall casing (2-gang)	Busch Jaeger, Reflex SI, white, incl. pre-cut cable outlet, suitable for 7441 000 002	7441 000 004
	In-wall casing (1-gang)	1-gang – depth: 47 mm 1-gang – depth: 61 mm	7441 000 005 7441 000 007
	In-wall casing (2-gang)	2-gang – depth: 47 mm 2-gang – depth: 75 mm	7441 000 006 7441 000 008